

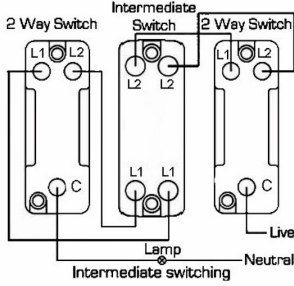

BOLFT32AB-W

Bloomsbury Ovolo Light Oak 2 gang 20AX Intermediate Toggle Antique Brass Fluted Dome/White Collar

Item Image	Wiring	Dimensions
		

Primary Range	Bloomsbury	
Insert Type	Intermediate Toggle	
Plate Finish	Bloomsbury Ovolo Light Oak	
Insert Colour	Ant Brs Flute Dome/White Colar	
Minimum Wall Box Depth	25mm	
Switched Poles	Single	
Current Rating	20AX	
Voltage	220/250V AC	
Maximum Load	20 Amp inductive	
Mains Frequency	50Hz	
IP Rating	IP2XD	
Contact Gap Minimum	3mm	
Terminal Capacity 1	5 x 1mm ²	
Terminal Capacity 2	4 x 1.5mm ²	
Terminal Capacity 3	2 x 2.5mm ²	
Terminal Capacity 4	2 x 4mm ² Multi-strand	
Terminal Capacity 5	1 x 6mm ²	
Earth Terminal Capacity 1	6 x 1mm ²	
Earth Terminal Capacity 2	5 x 1.5mm ²	
Earth Terminal Capacity 3	3 x 2.5mm ²	
Earth Terminal Capacity 4	2 x 4mm ² Multi-strand	
Earth Terminal Capacity 5	1 x 6mm ²	
Product Class 1	Must be earthed	
Ambient Operating Temperature	-5° to +40°C	
Recommended Location	Internal Use Only	
Maximum Installation Altitude	2000m	
Standard/Approval	BS EN 60669-1	
All products listed conform to current British or European standard and the product information is correct at the time of going to press.	All accessories are manufactured under an accredited BS EN ISO 9001 : 2015 Quality Management System.	It is the policy of the company to improve products as part of our development programme. Therefore, we reserve the right to alter designs and dimensions without prior notice.
Illustrations and diagrams are reproduced within the limitations of reproduction and printing process and are not binding.	Due to manufacturing processes we cannot guarantee an exact colour match and shadings of of certain finishes.	Correct as at 03 April 2017 11:51 AM E&OE

R Hamilton & Co Ltd, Unit 10 Carrick Business Centre, 4-5 Bonville Road, Brislington, Bristol, BS4 5NZ
 T: +44 (0)1747 860088 F: +44 (0)1179 710414
 E: info@hamilton-litestat.com www.hamilton-litestat.com

Registered Office 1 Rushmills, Bedford Road, Northampton NN4 7YB
 Registered in London No. 941624 VAT Registration No. 222 6607 84

